

# QUICK INSTALLATION GUIDE

[for MB40]

Mr12voltage

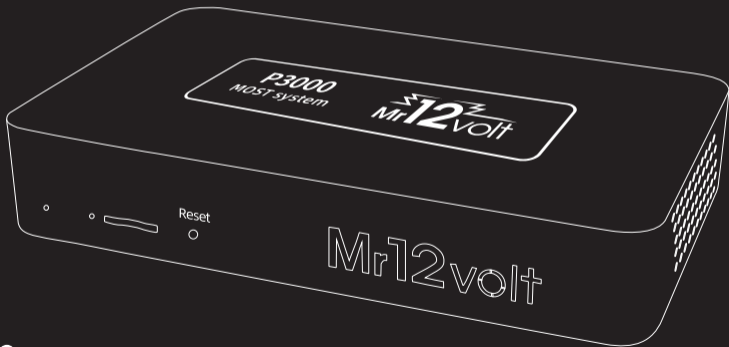

CarPlay



androidauto

# What's in the Box

---

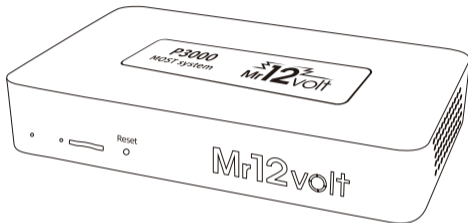

**Main Module**



**Quick Start Guide**

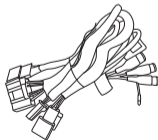

**Power Harness**



**LVDS Cable & Extension Cord**

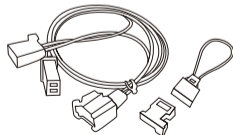

**FO Cable & Loop**

# Device Layout

---

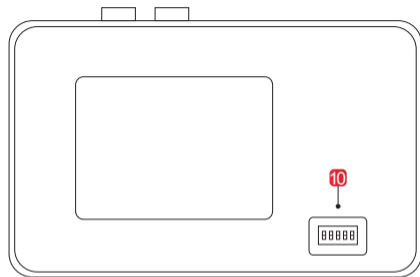
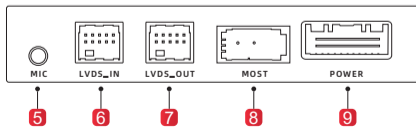

- 1 Power Indicator
- 2 Status Indicator
- 3 MicroSD slot - for (MCU) software updates only
- 4 Reset
- 5 Mic (Optional)
- 6 From Head Display
- 7 LVDS\_OUT
- 8 Fiber Optical (M.O.S.T)
- 9 Power
- 10 Dip Switches

# Remove Radio from Dashboard

---

Watch our installation videos  
on our YouTube channel :



Scan the QR code for Videos

[www.youtube.com/@mr12volt](http://www.youtube.com/@mr12volt)

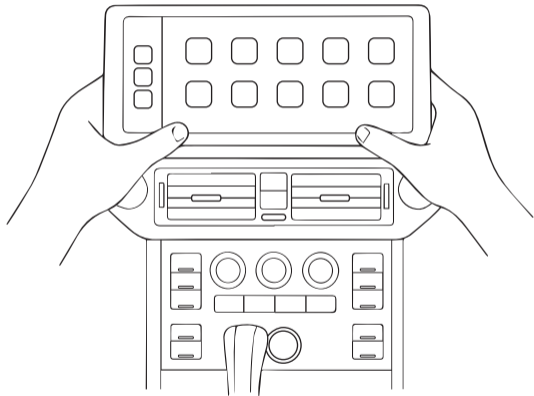

# Installation Wiring Diagram

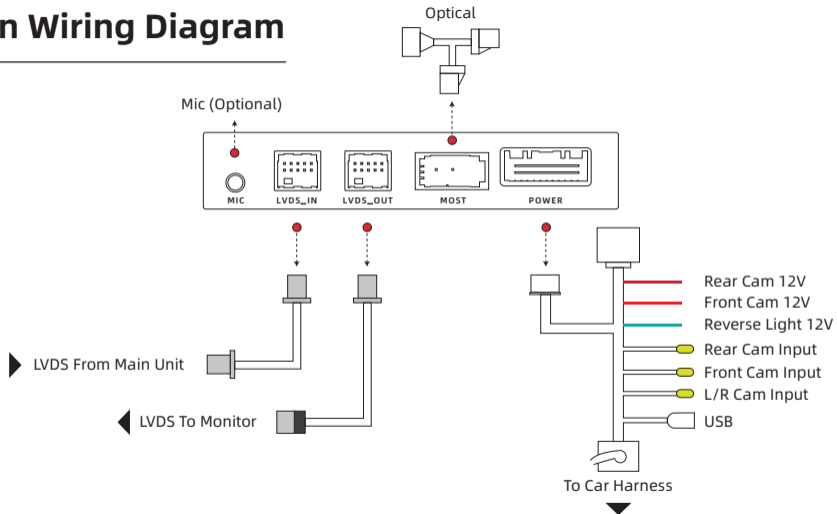

# QUICK START GUIDE

[for MB40]

Mr12volt

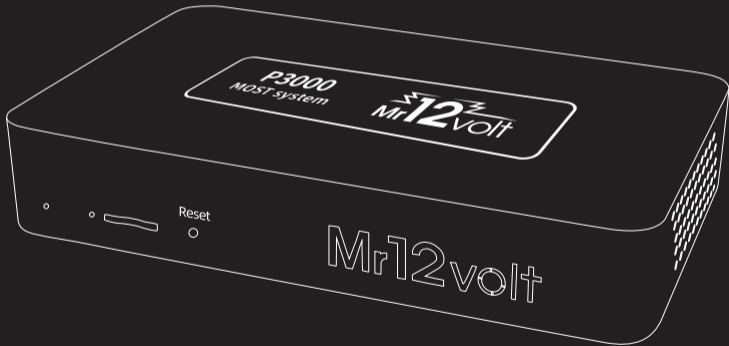

CarPlay



androidauto



## MR12VOLT Menu

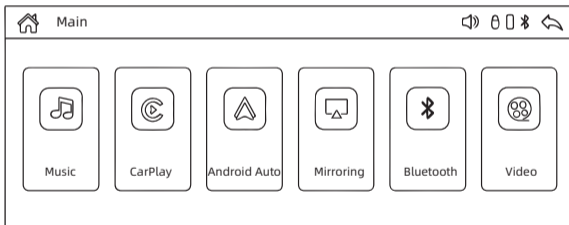
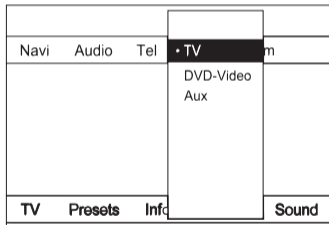

After selecting TV , the MR12VOLT menu appears.



---

## CarPlay

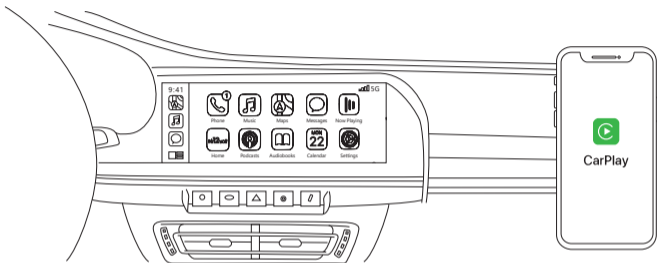

### How to connect CarPlay :

1. Search for **MR12volt\_xxxx** on your phone and pair it via Bluetooth.
2. Turn on "Wi-Fi" & use CarPlay.
3. CarPlay will appear on the screen. Please note that the first connection may take longer than usual.



---

## Android Auto

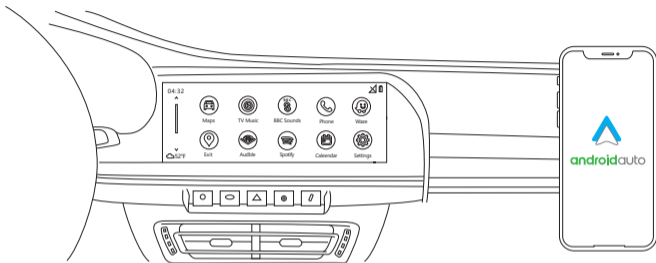

### How to connect Android Auto :

1. Search for **MR12volt\_xxxx** on your phone and pair it via Bluetooth.
2. The Wi-Fi on your phone will automatically turn on and connect to MR12volt for Android Auto.



---

## Mirroring

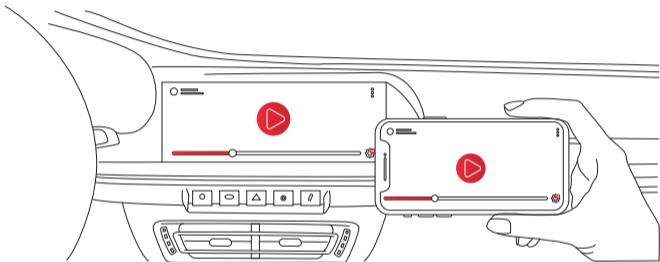

### Android Phone (Mirroring Setup)

1. Install the *Carletter Cast* application from the Google Play Store.
2. Follow the instructions in the application to complete the mirroring setup.
3. Both Bluetooth and Hotspot connections must remain active at all times for mirroring to work.