

QUICK INSTALLATION GUIDE

[for AU20 / AU26]

Mr12voltage



CarPlay



androidauto

What's in the Box

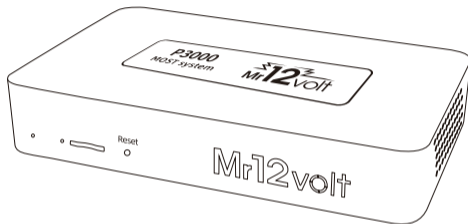

Main Module



Quick Start Guide

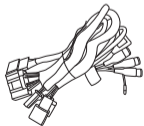

Power Harness

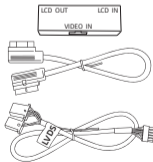

LVDS Cable Set



FO Cable



Gateway Harness



Microphone



Removal Keys

Device Layout

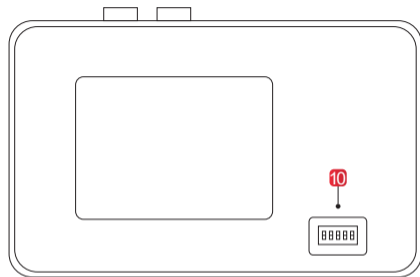
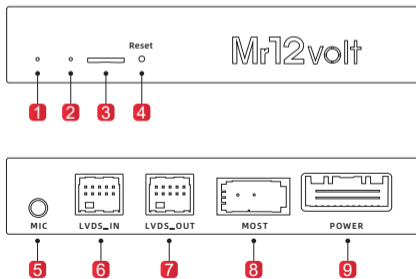

- 1 Power Indicator
- 2 Status Indicator
- 3 MicroSD slot - for (MCU) software updates only
- 4 Reset
- 5 Mic (Optional)
- 6 From Head Display
- 7 LVDS_OUT
- 8 Fiber Optical (M.O.S.T)
- 9 Power
- 10 Dip Switches

Remove Radio from Dashboard

Watch our installation videos
on our YouTube channel :



Scan the QR code for Videos

www.youtube.com/@mr12volt

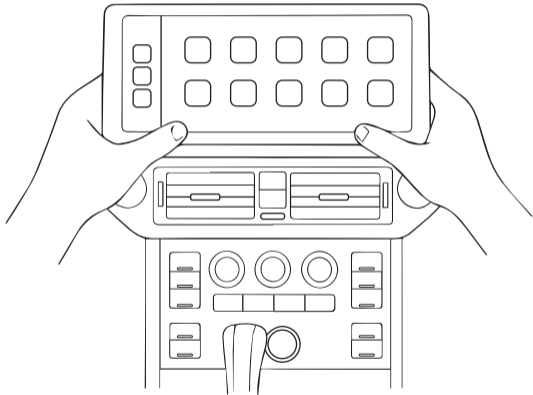

Installation Wiring Diagram

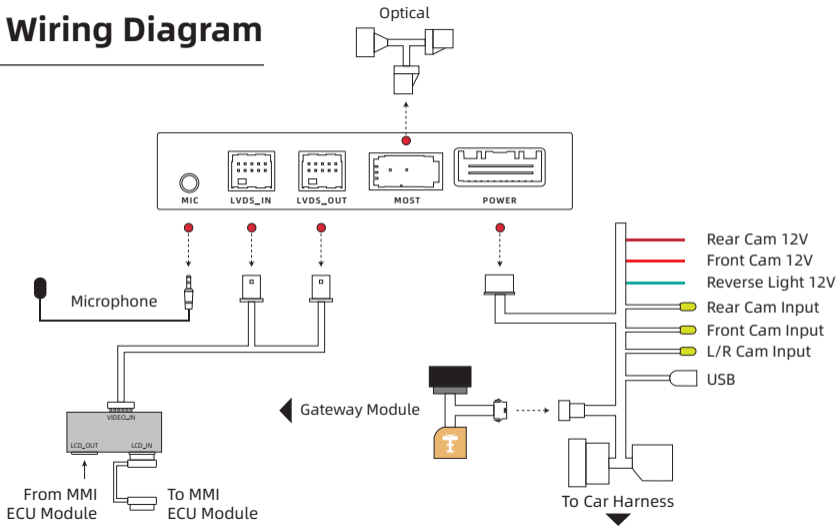

QUICK START GUIDE

[for AU20 / AU26]

Mr12volt

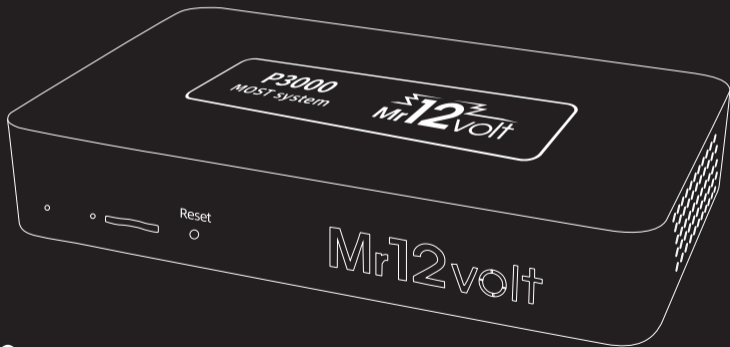

CarPlay



androidauto



MR12VOLT Menu

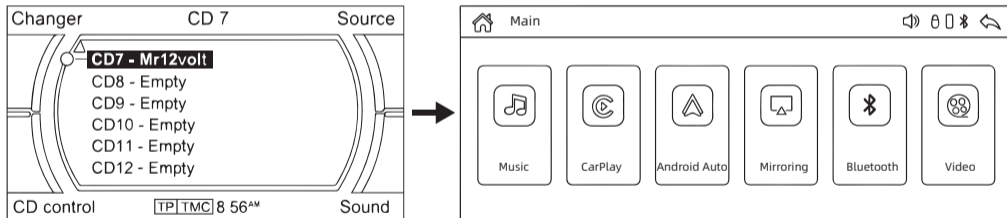

After selecting CD , the MR12VOLT menu appears.



CarPlay

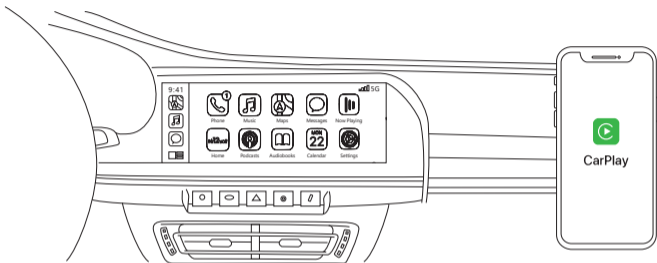

How to connect CarPlay :

1. Search for **MR12volt_xxxx** on your phone and pair it via Bluetooth.
2. Turn on "Wi-Fi" & use CarPlay.
3. CarPlay will appear on the screen. Please note that the first connection may take longer than usual.



Android Auto

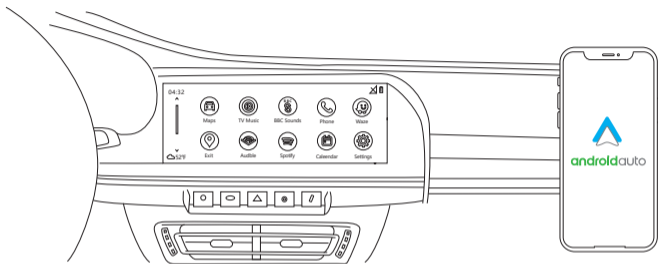

How to connect Android Auto :

1. Search for **MR12volt_xxxx** on your phone and pair it via Bluetooth.
2. The Wi-Fi on your phone will automatically turn on and connect to MR12volt for Android Auto.



Mirroring

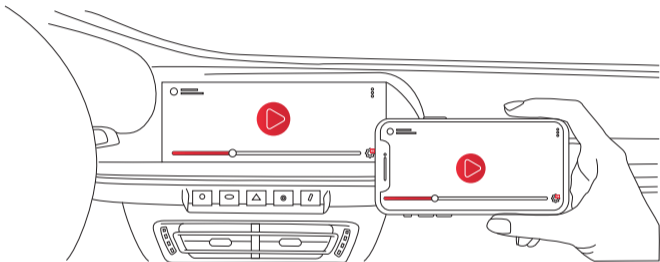

Android Phone (Mirroring Setup)

1. Install the *Carletter Cast* application from the Google Play Store.
2. Follow the instructions in the application to complete the mirroring setup.
3. Both Bluetooth and Hotspot connections must remain active at all times for mirroring to work.